

Ax1

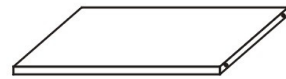

Dx1



Gx4

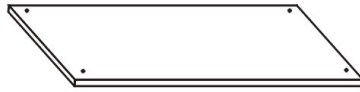

Bx1

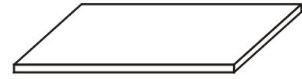

Ex1



Hx4

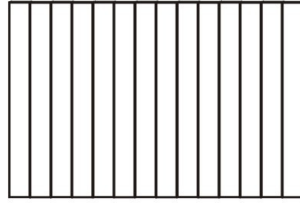

Cx2

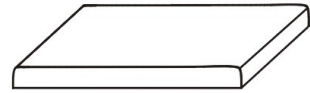

Fx1



Ix8



Jx8

1

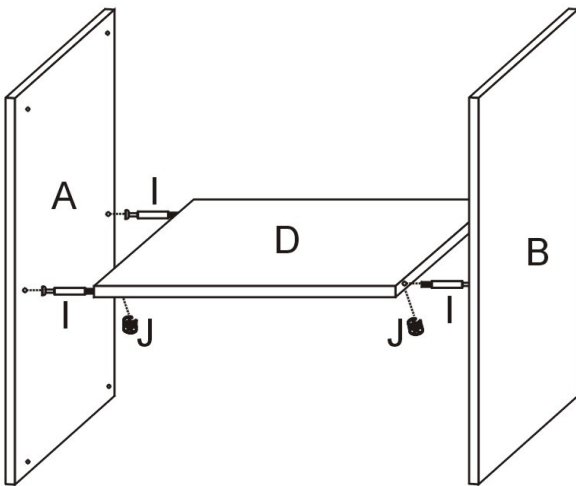

2

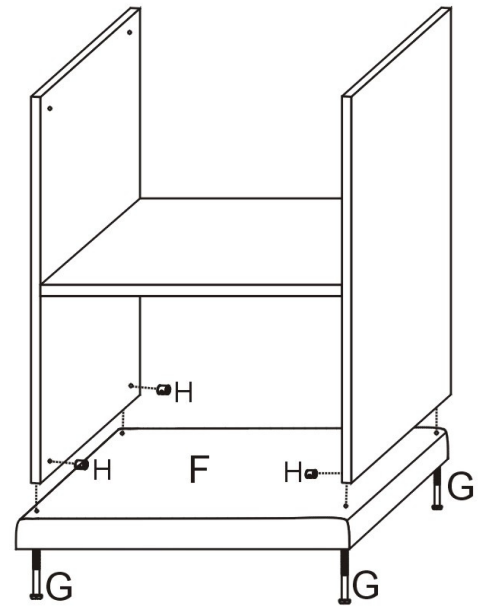

3

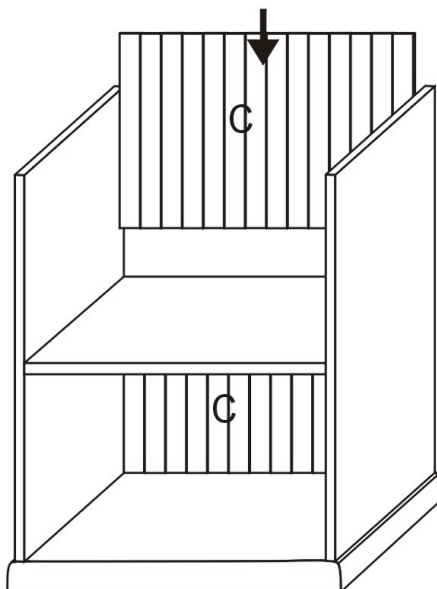

4

